

Technika

EXCLUSIVELY FROM **TESCO**

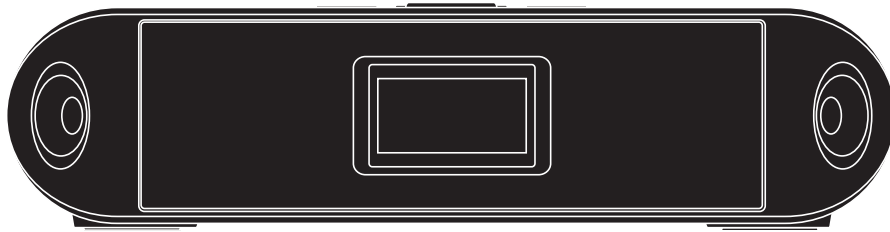

SP-129I

Owner's Handbook

Clock radio for iPod



IMPORTANT SAFETY INFORMATION

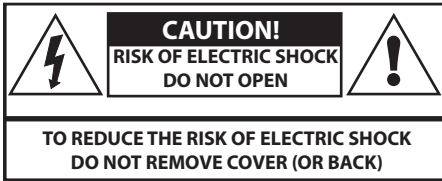

This symbol indicates that there are important operating and maintenance instructions in the literature accompanying this unit.



This symbol indicates that dangerous voltage constituting a risk of electric shock is present within this unit.

Read these instructions.

Keep these instructions.

Heed all warnings.

Follow all instructions.

Do not use this apparatus near water.

Clean only with a slightly damp cloth.

Do not block any ventilation openings.

Install in accordance with the manufacturer's instructions.

Do not install or operate near any heat sources such as radiators, stoves, or other apparatus that produce heat.

Unplug this apparatus during lightning storms or when unused for long periods of time.

Refer all servicing to qualified service personnel. Servicing is required when the apparatus has been damaged in any way, such as the power-supply cord or plug is damaged, liquid has been spilled or objects have fallen into the apparatus, the apparatus has been exposed to rain or moisture, does not operate normally, or has been dropped.

Warning: To reduce the risk of fire or electrical shock, do not expose this product to rain or moisture. The product must not be exposed to dripping and splashing and no object filled with liquids such as a vase of flowers should be placed on the product.

No naked flame sources such as candles should be placed on the product.

Caution: Changes or modifications not expressly approved by the manufacturer could void the user's authority to operate this device.

Caution: Usage of controls or adjustments or performance of procedures other than those specified herein may result in hazardous exposure.

IMPORTANT

This equipment generates, uses and can radiate radio frequency energy and, if not installed and used in accordance with the instructions, may cause harmful interference to radio communication. However, this is no guarantee that interference will not occur in a particular installation. If this equipment does cause harmful interference to radio or television reception, which can be determined by turning the equipment off and on, the user is encouraged to try to correct the interference by one of the following measures:

- Reorient or relocate the receiving antenna.
- Increase the separation between the equipment and receiver.
- Connect the equipment into an outlet on a circuit different from that to which the receiver is connected.
- Consult the dealer or an experienced radio/TV technician for help.

ELECTRICAL INFORMATION

Mains Supply: The mains operating voltage of this unit is marked on a rating plate on the rear of the unit.

The means of disconnecting this appliance from the mains supply is the mains plug. This should be unobstructed and readily operable at all times.

INDEX

INDEX

Important safety information	1
Introduction	2
Controls & Connections.....	3
Display features	5
Remote control	6
Getting started	6
Clock and alarm setting	7
Selecting a source and setting volume	8
Listening to FM radio.....	8
iPod adaptors	9
iPod docking and control	10
Aux In connection and play.....	11
Troubleshooting	11
Care & Maintenance.....	12
Specifications	12
Warranty	12

INTRODUCTION

The SP-129I is a full-function, remote controlled, dual alarm clock radio with iPod docking station.

The video output enables connection of a TV to watch video and movie programs from a video equipped iPod.

PRELIMINARIES

UNPACKING

Carefully unpack the unit. If it is damaged, please return it to your nearest Tesco store for replacement. Remember to take your purchase receipt with you.

Retain the User Handbook. If you pass the unit on to a third party make sure you pass on the handbook.

We suggest you retain the packaging. If you dispose of it, do so having regard to any recycling regulations in your area.

CONTENTS

The carton should contain:

- The SP-129I Clock radio
- Remote control with battery
- AC power cord
- AUX in/Video out cable
- Set of 4 x iPod adaptors
- Operating Manual

If any items are missing or damaged, contact your nearest TESCO store for a replacement. Have your receipt ready when you call. Retain the packaging. If you dispose of it, do so having regard to any recycling regulations in your area.

LOCATION

Place the unit on dry stable surface away from heat and damp and where it is unlikely to fall or be knocked over.

CONTROLS AND CONNECTIONS

FRONT VIEW

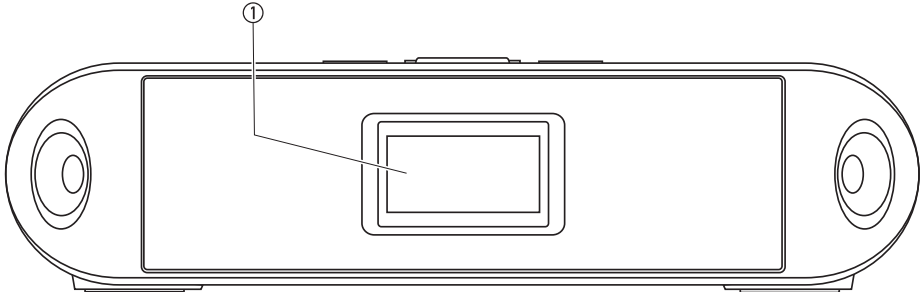

BACK VIEW

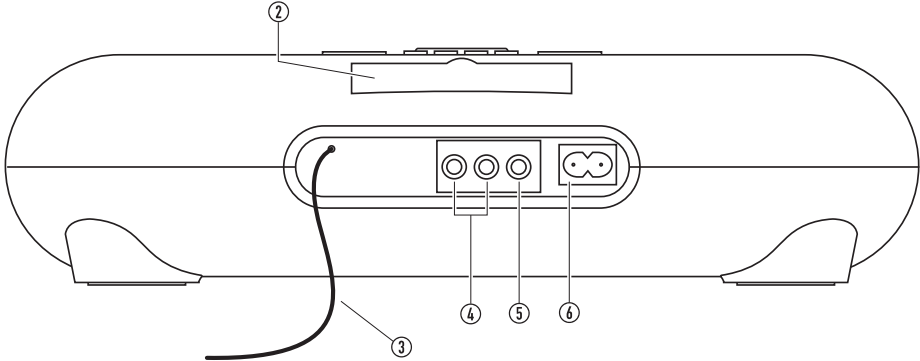

- ① Display window
- ② iPod dock cover
- ③ Radio aerial
- ④ Audio inputs
- ⑤ Video output
- ⑥ AC power input

CONTROLS AND CONNECTIONS

TOP VIEW

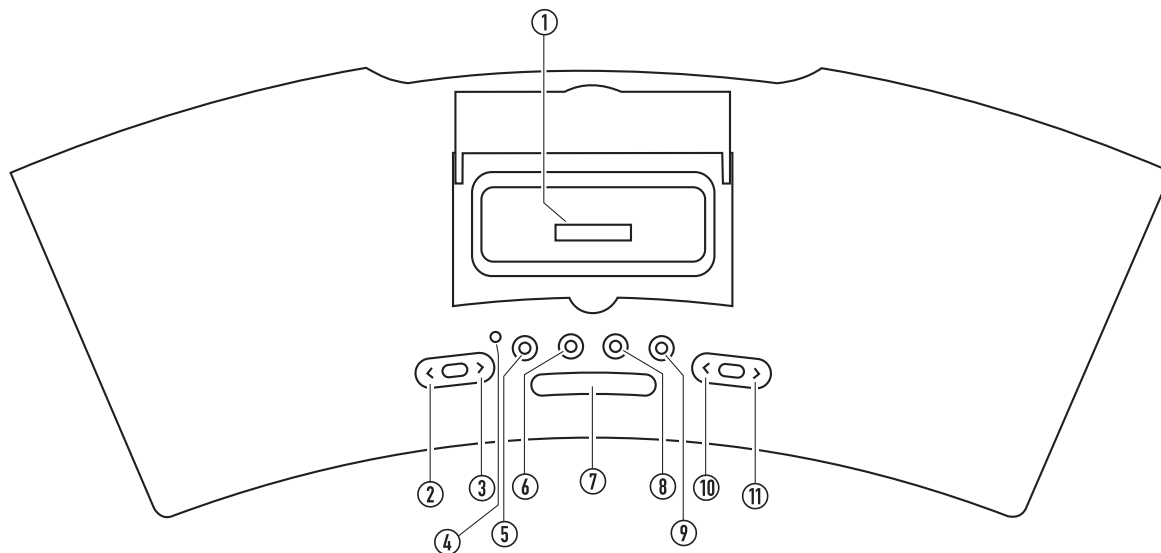

- ① iPod dock
- ② Previous/Alarm 1 button
- ③ Next/Alarm 2 button
- ④ Standby indicator
- ⑤ Standby button
- ⑥ Sleep/Time display button

- ⑦ Snooze button
- ⑧ Source button
- ⑨ Play/pause button (Stereo/Mono for FM)
- ⑩ Volume down button
- ⑪ Volume up button

DISPLAY FEATURES

DISPLAY ICONS

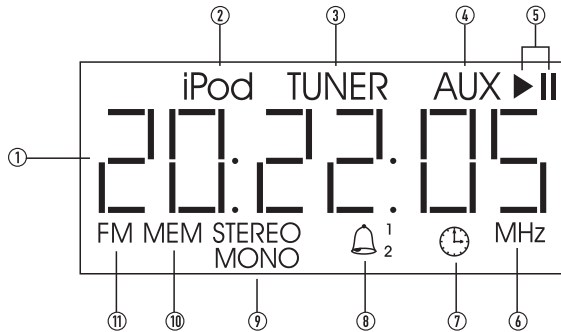

- ① Numeric display of time/frequency
- ② iPod mode
- ③ Tuner (FM) mode
- ④ Aux In mode
- ⑤ Play/Pause symbols
- ⑥ MHz indicator (Tuner mode)
- ⑦ Time display indicator
- ⑧ Alarm display indicators
- ⑨ Stereo/Mono indicators
- ⑩ Preset memory indicator
- ⑪ FM Indicator (Tuner mode)

TIME DISPLAY



When in Standby mode, press the SLEEP button briefly to switch to the time display. The time is shown in hours, minutes and seconds.

FM DISPLAY



When FM radio is playing the display will show the tuned frequency and STEREO or MONO indication.

iPod DISPLAY



Track number

Elapsed time

When an iPod is playing, the display will show the album or playlist track number (from the iPod) and the elapsed time of the track.

NOTE:- When the track number is greater than 99, the display will show the elapsed time only. The track number will be shown briefly when a track or album selection is made.

REMOTE CONTROL

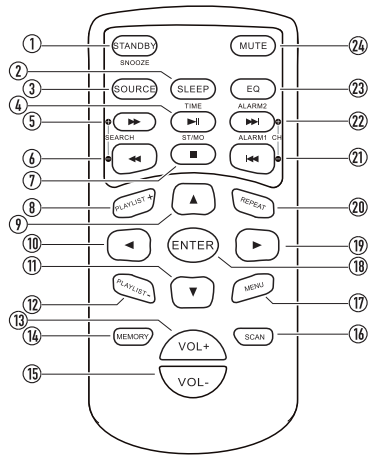

- | | |
|--------------------------|---------------------------|
| ① Standby/Snooze button | ⑬ Volume up button |
| ② Time/Sleep button | ⑭ Memory button |
| ③ Source button | ⑮ Volume down button |
| ④ Play/Pause/Mono button | ⑯ Scan button |
| ⑤ Search up button | ⑰ Menu button |
| ⑥ Search down button | ⑱ Enter button |
| ⑦ Stop button | ⑲ Right button |
| ⑧ Playlist + button | ⑳ Repeat button |
| ⑨ Up cursor button | ㉑ Previous/Alarm 2 button |
| ⑩ Left cursor button | ㉒ Next/Alarm 1 button |
| ⑪ Down cursor button | ㉓ EQ button |
| ⑫ Playlist - button | ㉔ Mute button |

REMOTE CONTROL BATTERIES

BEFORE FIRST USE

To prepare the remote control for first use, pull out the safety strip to activate the battery.

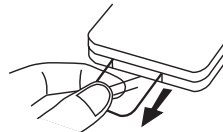

REPLACING THE BATTERY

When replacing the battery in the remote control, refer to the diagram below.

1. Press the catch across.
2. While holding the catch, open the battery door.

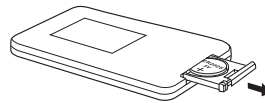

3. Fit the battery observing polarity as shown. When replacing the battery, use only the same CR2025 type specified.

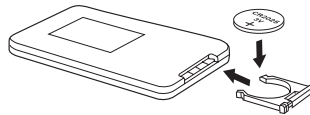

BATTERY DISPOSAL

Dispose of used batteries with regard to the recycling regulations in your area. Do NOT short circuit batteries or throw them into water, the general rubbish or in a fire.

Weak batteries can leak and damage the remote control. Replace them in good time!

GETTING STARTED

FM AERIAL

Before using your radio, unwrap and extend the aerial wire. You may need to adjust the position of the aerial wire for best reception.

CONNECTING POWER

- Check that the mains voltage marked on the rating plate on the back panel is the same as the voltage in your area.
- Plug the AC power cord into the AC inlet
- Plug the mains plug into the wall socket and switch the mains power on.

POWER CONTROL

To turn the clock/radio on:

- Press the **Standby** button on the top panel or remote control.

The display will light and the unit will begin to play.

To turn the clock/radio off:

- Press the **Standby** button on the top panel or remote control.

The display will switch off and the Standby indicator will light.

TIME DISPLAY AND LIGHT

To switch on the time display and light at any time when the unit is set to Standby, press the **SLEEP/TIME** button on the top panel or the **SLEEP/TIME** button on the remote control briefly.

CLOCK AND ALARM SETTINGS

The clock and alarms are set in Standby mode.

You can choose to set two different alarm times (ALARM 1 and ALARM 2) and choose from Radio, iPod, or Aux sources or a buzzer to wake to.

You can then choose to set either or both alarms to wake you.

To enter clock setting mode:

- Set the clock/radio to Standby.
- Press and **hold** the **SLEEP/TIME** button on the top panel or the **SLEEP/TIME** button on the remote control.

The display will light and the unit will now enter clock/alarm setting mode. Clock and alarm settings are made in the sequence shown below -

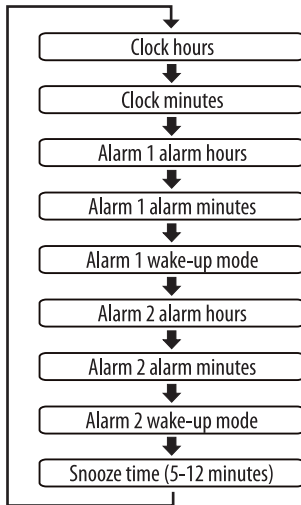

Whilst in clock setting mode:

- To adjust the setting that is currently flashing on the display, press the **▶▶** or **◀◀** button.
- To move on to the next setting in the list, press the **SLEEP/TIME** button briefly.
- Repeat this sequence until you have made all necessary adjustments.

Snooze time is the last setting. When this is complete, the display will switch off and the unit will revert to Standby.

ACTIVATING THE ALARMS

If you want the alarm to wake you, then you must activate it before going to bed.

NOTE:- You can activate one alarm at a time, not both simultaneously.

To activate an alarm:

- Before setting the unit to Standby, play your wake-up source and set the volume to a comfortable level to wake up to.
- Set the unit to Standby.
- Press the **ALARM 1** or **ALARM 2** button repeatedly to activate or switch off either alarm.

When the alarm is set to wake you, the ALARM 1 or ALARM 2 symbol will show on the display.

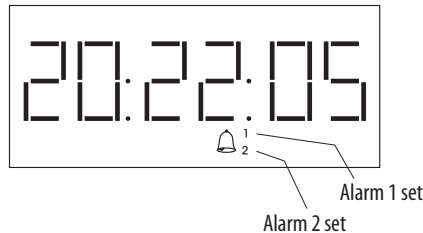

WHEN THE ALARM SOUNDS

The alarm will sound for a period of one minute, playing your selected alarm mode with a level that increases gradually to the level you set. When the alarm sounds you can choose to switch it off or to set Snooze mode and extend the alarm for another 5-12 minutes (snooze time can be set during alarm setting).

To switch off the alarm:

- Press the **Standby** button to switch off the alarm.

To set Snooze mode:

- Press the **SNOOZE** button.

The alarm will switch off, then repeat after the set snooze period.

You can repeat the snooze period up to 10 times.

ALARM REPEAT

If either (or both) alarms are set to wake you, the alarm(s) will sound at the same time each day until de-activated.

IMPORTANT NOTES ABOUT ALARM OPERATION

- If you set the wake-up mode to 'iPod' make sure that an iPod is docked and set to play a music album or playlist (not a video program).
- If you set the wake-up mode to AUX IN, make sure that a suitable source is connected to the AUX-IN jacks and that it will be playing when the alarm sounds.

SELECTING A SOURCE

You can choose to play music from FM radio (TUNER), a docked iPod or a personal audio player or other source connected to the AUX input on the rear panel.

To select a source:

- Press the **SOURCE** button to cycle through the sources.

The selected source (TUNER, iPod or Aux) will be shown on the front panel display.

NOTE:- The iPod source option will only appear for selection when an iPod is docked.

ADJUSTING THE VOLUME

To increase the volume:

- Press the **VOL+** button.

To decrease the volume:

- Press the **VOL-** button.

While the volume is being adjusted, the display will switch to show the volume setting on a scale of 0-30.

LISTENING TO FM RADIO

To listen to FM radio:

- Switch on the power by pressing the **STANDBY** button.
- If FM mode is not selected, press the **SOURCE** button repeatedly until 'TUNER' appears on the display.

The tuned frequency is displayed with stereo or mono indication.

To tune to a station:

The radio is tuned from the remote control.

You can choose to tune automatically to the next station in the band, to tune manually or to scan the band for stations automatically and store those found in preset locations (auto programming).

Tuning automatically:

- Press and hold the **▶▶** or **◀◀** button to scan up or down the band.

The radio will scan the band and stop at the next station.

Tuning manually:

- Press the **▶▶** or **◀◀** button briefly to step up or down the band manually.

The radio will tune the band in 50kHz steps.

Auto programming:

- Press the **SCAN** button to automatically program the radio presets.

The radio will tune the band and store each station found in a preset location. This process may take a few minutes and will erase stored presets. The preset stations can then be recalled.

STEREO/MONO SELECTION

- To change between stereo and mono reception, press the **▶||** button.

The display will show stereo or mono indication.

PRESET STATIONS

Radio presets

Your radio can store up to 20 of your favourite stations as presets for quick recall.

Station presets are stored from the remote control.

To store a preset

- Tune to the station you want to store as a preset.
- Press the **MEMORY** button.

The 'MEM' symbol will flash on the display.

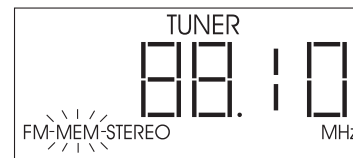

- Press the **▶▶** or **◀◀** button to locate the preset number you want to store.
- Press the **MEMORY** button to store the preset.

The station will be saved and the 'MEM' symbol will stop flashing..

NOTE: You can choose a preset number that is already in use. The new station details will over-write the stored station.

To recall a preset

- When playing FM radio, press the **▶▶** or **◀◀** button to step through the preset stations.

Each preset station will tune and the frequency will be displayed.

iPod ADAPTORS

Before docking your iPod you must first check if your iPod has a docking connector. Early iPod models do not have one and cannot be docked to your unit. The docking connector is located on the base of the iPod as shown below.

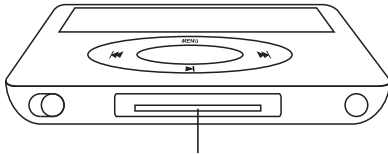

Docking Connector

Before docking your iPod, you must first fit the correct iPod adaptor to the docking bay. Each iPod adaptor matches the shape of a particular iPod and is necessary to ensure that your iPod is securely held when docked.

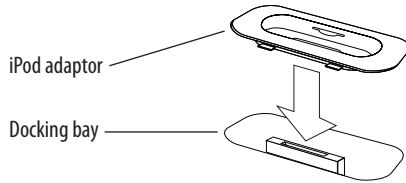

iPod adaptor

Docking bay

FINDING THE CORRECT iPod ADAPTOR

Your iPod docking system is supplied with a selection of docking adaptors that are compatible with several models in the iPod range. Refer to the table of iPod models in the next column which lists the adaptor numbers (marked on the adaptor), compatibility and instructions for obtaining an adaptor for unlisted models.

NOTE: Do not dock an iPod without fitting the correct adaptor, you may damage the iPod and your unit.

SELECTING AN ADAPTOR

LIST OF SUPPLIED ADAPTORS

- ⑧/⑪ iPod nano (1st Gen & 2nd Gen).
- ⑨ iPod video (30GB), iPod classic (80GB & 120GB).
- ⑩ iPod video (60GB & 80GB), iPod classic (160GB).
- ⑰ iPod nano (4th Gen).

Other iPod models with dock connectors

Your iPod may have been supplied, packed with a standard dock adaptor. If so, this can be used as the docking bay on your unit is compatible with adaptors supplied by Apple.

If you don't have a dock adaptor

If your iPod was not supplied with a standard dock adaptor, you can buy one from Apple on-line. To determine the exact model of your iPod, refer to this web-link - <http://support.apple.com/kb/HT1353>. You can then browse the iPod accessories page on the Apple website to find an adaptor for your iPod model that can be purchased on-line.

Once you have located the correct adaptor for your iPod, press it gently into the iPod Docking Bay before attempting to dock your iPod.

CONNECTING OTHER iPod MODELS (INC SHUFFLE)

To connect an iPod via the AUX IN jacks:

- Using a 3.5mm stereo jack to dual RCA phono cable (not supplied), connect one end of the cable to the headphone socket of the iPod, and the other end to the AUX IN jacks on the back panel.

Headphone socket

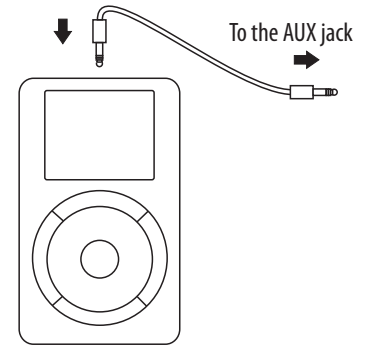

- To listen to your iPod, follow the instructions on page 11 for playing equipment connected to the AUX jack.

NOTE:- The volume control of the iPod must be turned up when playing through the AUX jack.

NOTE:- An iPod connected to the AUX jack cannot be operated from the remote control and will not be activated by the alarm.

DOCKING AN iPod

DOCKING YOUR iPod

To dock your iPod:

- Switch off the power.
- Open the cover over the iPod dock.
- Check that the correct iPod adaptor is fitted to the docking bay.
- Locate the iPod on the Docking Connector and press it gently home.

To remove your iPod from the dock:

- Grip the iPod at the sides.
- Lift the iPod gently from the dock.

CHARGING AN iPod

When an iPod is docked and the unit is switched on, the iPod will begin to charge automatically.

PLAYING FROM AN iPod

Once an iPod is docked, you can operate your iPod functions from the controls on the remote control.

Playback functions available from the top panel controls or remote control:

- Press the ►|| button to toggle between Play and Pause mode at any time.
- Press the ►► or ◀◀ button to select the previous or next track on your iPod.
- Press and **hold** the ►► or ◀◀ button to fast search forwards or backwards through a track.

Additional functions available from the remote control:

- Press the ■ button to stop playback
- Press the ►► or ◀◀ button to fast search forwards or backwards through a track.
- Press the **PLAYLIST+** or **PLAYLIST-** button to select the next or previous playlist.
- Press the **REPEAT** button to cycle through the repeat modes available on your iPod. The mode set will show on the iPod display.

iPod menu functions:

You can press **MENU** and the cursor buttons, ▲ ▼ on the remote control to navigate the iPod menus.

- To move up through the iPod menu, press **MENU** on the remote control.
- To scroll up and down options displayed on the iPod menu, press the ▲ ▼ cursor buttons.
- To select menu items, press the **ENTER** button on the remote control.

iPod VIDEO PLAYBACK

If you dock an iPod Video you can view the photo or video program from the iPod on a TV monitor via your radio, whilst listening to any soundtrack through the radio speakers.

NOTE: The TV must be equipped with a Composite Video (CVBS) input.

Connecting an external TV monitor:

- Connect the yellow plug of the 3-way AV cable (supplied) between the VIDEO OUT jack on the back panel of your radio and a suitable Composite video (CVBS) input of your TV. This is often located on the front or side of the TV.

NOTE:- The red and white plugs are not used for video connection.

Switching on the iPod video output:

Before viewing photo or video programs on your TV you will need to switch on the iPod video output. The iPod video output selector is generally found as follows -

- Navigate to the 'Videos' or 'Photos' menu of the iPod.
- Select 'Settings'.
- Select 'TV out'.
- Set 'TV out' to On.

The video out signal from the iPod will now be enabled.

Selecting the correct input on your TV:

- Set the TV input selector to the AV input that you used when connecting the AV cable.

You can now play the iPod and set the volume level on the radio.

Viewing photos on your TV:

- Navigate to the Photos menu of your iPod.
- Press enter to select the photo you want to see.
- Press enter again to view the photo on your TV.

AUX SOURCES

The AUX IN input may be used to connect sound sources with a Line or Headphone analogue output to play through your unit. These may include -

- iPod models that cannot be docked to the unit
- MP3 players
- CD walkman players
- Tape walkman players
- Personal computers or laptops

Connecting to the AUX IN jack

To connect to the AUX IN jack you will need a stereo 3.5mm jack to twin phono jack cable (not supplied).

- Connect the cable between the headphone or LINE/AUX output of the personal audio player and the AUX IN jacks on the back panel.

Playing the AUX source

- With the cable connected, press the **SOURCE** button to select AUX mode.

The AUX symbol will light on the front panel display.

- Set your personal audio player/computer to PLAY.
- Set the listening volume to the level you want.

If there is no sound or if the volume level is not loud enough, you may need to increase the volume setting on your personal audio player/computer.

TROUBLESHOOTING

Alarm not sounding at the correct times

Check that the clock is set correctly (clock display is 24 hour) and that the time settings are correct for the alarm(s) you are using.

iPod not playing when the alarm activates

If you have an iPod with video, check that you have selected a music album or playlist on the iPod. The iPod will not autoplay movies or music video programs at wake-up time.

Alarm sound not audible or too loud:

Make sure that your preferred volume is set before going to bed.

No sound/low volume from AUX source:

Check that the volume control is turned up on the AUX source.

No video picture when playing iPod photos or video:

Check that the iPod video output is enabled.

CARE AND MAINTENANCE

CARE AND CLEANING

All care and cleaning operations should be carried out with the unit unplugged from the mains power.

The surface of the unit can be cleaned with a barely damp cloth and then dried carefully. Never use abrasives, abrasive cloths or chemical solvents.

SPECIFICATIONS

SPECIFICATIONS

Supply Voltage: 100-240V ~, 50/60 Hz

Power consumption 15W

Output power..... 3W x 2

FM tuning range 87.5-108MHz

Net Weight: 1.29 kg



Class II construction double insulated.

This product must not be connected to earth.



UK: Waste electrical products/batteries should not be disposed of with household waste. Separate disposal facilities exist, for your nearest facilities see www.recycle-more.co.uk or in-store for details.

ROI: Produced after 13th August 2005. Waste electrical products/batteries should not be disposed of with household waste. Please recycle where facilities exist. Check with your Local Authority or retailer for recycling advice.

WARRANTY

Your Tesco appliance is covered by a warranty for 12 months from the date of purchase. If a fault develops during this period, please contact the TESCO electrical help line on 0845 456 6767. Please have your original purchase receipt with you when you call. This warranty in no way affects your consumer rights.

Technika

Tesco Stores Ltd,
Delamare Road, Cheshunt, Herts, EN8 9SL

▲ **Technika Helpline: 0845 456 6767** (Calls cost up to 4p per minute from a BT landline, other providers may vary)

SP129IV0.3